

Modern and economical systems

WARM-AIR HEATING, VENTILATION WITH HEAT RECOVERY

- low-energy residences
- energy-passive residences
- residential pools



DUPLEX RK3 - heating unit ventilator with heat recovery
- with EC fans

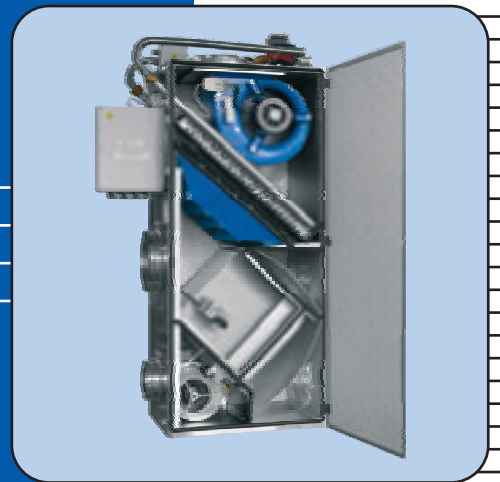

DUPLEX RDH
- heating unit ventilator
with heat recovery

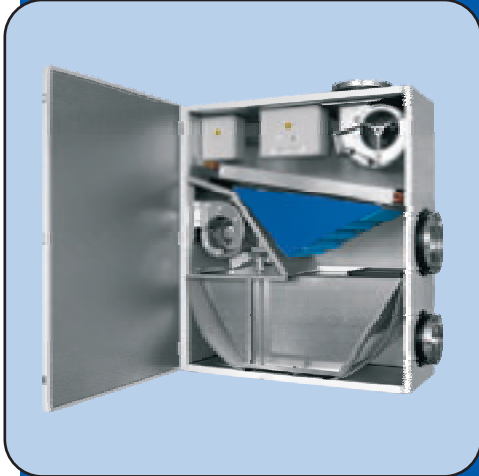

DUPLEX RB
- heating unit ventilator
with heat recovery

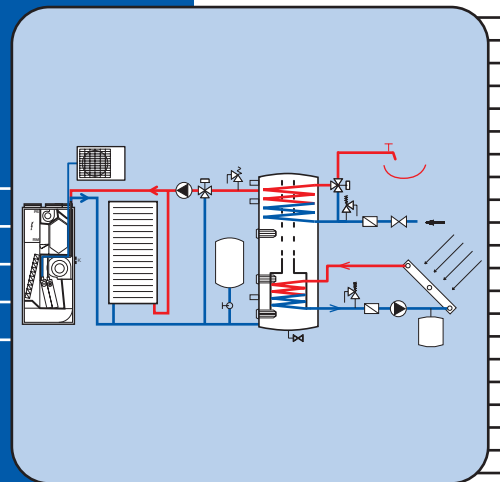

Integrated system
of a heat supply for
a family house
Including cooling

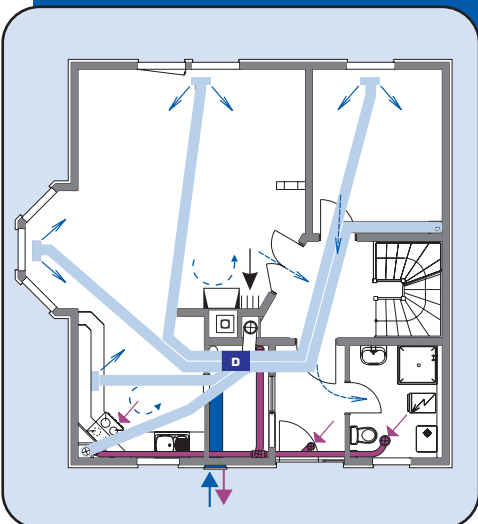

Warm-air heating
and ventilation
of a family house



RESIDENTIAL VENTILATION & HEATING DIVISION

ATREA s.r.o., V Aleji 20
466 01 Jablonec n. N.
Czech Republic



Phone: 483 368 133
Fax: 483 368 112
E-mail: rd@atrea.cz

www.atrea.cz

IMPORTANCE OF BUILDING VENTILATION

Building's indoor climate can be evaluated based on the following criteria:

A correct thermal-humidity quality is the most important element for ensuring a healthy indoor environment of buildings.

The recommended hygienic value of higher air RH (50 to 70 %) that prevents dryness of mucous membranes, commonly causes mold formation (e.g. the *Alternaria* or *Aspergillus* family), mainly in cool and poorly ventilated room corners, heads and linings. This results in increasing resident sickness figures, frequent nausea, allergies, bronchitis etc.

Those phenomena gain strength when inappropriately weatherstripping windows without an appropriate air intake compensation. In addition, with higher RH value (above 60 %) percentage of surviving organisms doubles (e.g. *Staphylococcus*, *Streptococcus*) in respect to RH value of 30 to 40 %.

With decrease of the RH value number of mites in textiles and resulting allergies (asthma) dramatically decreases.

To the major humidity sources in buildings belong mainly human metabolism (produces 50 to 250 g of water vapor/h/1, based on activity), bathrooms (produce 700 to 2600 g of water vapor/h), kitchens (produce 600 to 1500 g of water vapor/h) and laundry drying (produce 200 to 500 g of water vapor/h/5 kg).

In many rich countries it is recommended for keeping the optimum RH value (between 35 to 45 %) that a forced ventilation of apartments with ACH value of $n = 0,3$ až $0,5$ (h^{-1}) be applied.

Microbial quality is created by microorganisms of bacteria, viruses, fungi, spores and pollens. Allergic syndroms from spores of different types of fungi and pollen particles become very serious problem these days. The most efficient method to reduce the microbial concentrations in buildings till now is a thorough ventilation using clean outdoor air.

Aerosol quality - aerosols occur in air in form of solid particles (dust) or fluid particles (mist).

Building dust, mainly particles smaller than 1 mikrometer, is other main cause of asthma.

Odour quality - next to a common odours (smoke, food preparation) styrenes, formaldehydes and paint vapors, substances not known before, occur in today's interior.

In general, concentration of 0,10 % CO_2 (Pettenkofer criterion) is stated as a comparative and exact measured value; for removal of feeling of stale air caused by human odours even 0,07 % CO_2 (tj. 700 ppm = 1 300 $mg \cdot m^{-3}$) value is used.

Quality of odour in buildings can only be affected basically a sufficient intake of fresh air. Basic and worldwide recognized value of ventilation intensity for removal of common body odours (for not adapted persons) is 25 m^3 /hour of fresh outdoor air per person.

Toxic quality is created by toxic gasses with pathological effects. The most unhealthy gas in buildings' interior is CO. Poorly ventilated kitchens with gas stoves have NO_x occurrence up to 50 micrograms/ m^3 which has evidently cancerogenic effect.

Higher concentration of formaldehyde causes irritation of eyes and mucous membranes. It also is an allergen and potential cancerogen.

PRESENT STATE

Tougher requirements on quality of residential building envelope and reduction of uncontrollable infiltration through cracks bring many problems:

- natural interior airchange declines below $n < 0,05$ (h^{-1}) which is totally unacceptable from a hygienic point of view
- with stable average-family water vapor production in an apartment (up to 10 l/day) fungi with very negative effects to human health occur
- condensed moisture has a negative effect on appearance and lifetime of building structure
- reduction of building heat loss brings problems with balancing of standard water heating systems
- buildings overheat due to a summer solar gain almost without possibility of natural ventilation

RULES FOR LOW-ENERGY BUILDINGS

The new issue of CSN 730540 - 2 (2007) Thermal insulation of buildings adopted in accordance with the EU much tougher values of heat transfer factors through all exterior structures. Also, new CSN 15251 specifies hygienic requirements for air change in buildings and use of controlled ventilation with heat recovery. Very important is building leakage (air-tightness) control in accordance with CSN EN 13829 (blower-door test). Purpose of these radical changes mainly the reduction of building operation energy use and improvement of the indoor air quality. The future belongs to low-energy (and passive) residential buildings where calculated heat consumption for heating is, according to EU regulations, lower than 50 (15) $kWh/m^2/year$, with the following major rules defined:

1. Suitable building orientation
2. Orientation of rooms south to utilize pasive solar gains
3. Compact building shape (A : H ratio) with optimum glazing area
4. Avoidance of thermal bridges
5. Very low heat transfer values for the building envelope:
exterior walls: $U < 0,15$ W/m^2K ;
roof: $U < 0,12$ W/m^2K ; windows: $U < 1,0$ W/m^2K
6. Low energy cost of building materials production (e.g. Suitability of wood buildings)
7. Perfect tightness of the whole building (measured by the Blower door test according to EN 13829, i.e. $n \ll 0,6$ (h^{-1}) at $\Delta p = 50$ Pa)
8. Installation of controlled ventilation with heat recovery, preferable in combination with a flexible warm-air heating and indoor heat gain utilization
9. Installation of bivalent (supplemental) biomass heat source (fireplace insert, stove)
10. Installation of solar systems to support space and HSW heating, with low-temperature accumulation

COMPARISON OF ENERGY PARAMETERS

Parameter	unit	old method of building family houses	low-energy houses (NERD)	energy pasive houses (EPD)
Heating & ventilation heat consumption *)	$kWh/year$	up to 25 000	up to 9 800	< 2 100
Specific calculated heat input for heating & ventilation	W/m^2	> 110	20 - 40	< 10
Specific heat consumption - for space heating and forced ventilation	$kWh/m^2/a$	170 - 220	30 - 70	≤ 15
Specific heat consumption - for HSW heating	$kWh/m^2/a$	35	< 20	10 - 15
Specific consumption of electric energy in household (EI)	$kWh/m^2/a$	30	< 20	10 - 15
Total specific consumption (SH+AHU+HSW+EI)	$kWh/m^2/a$	235 - 285	70 - 110	35 - 45
Total consumption of primary fuel PEZ	$kWh/m^2/a$	-	-	< 120
Min. required heat transfer factor - through walls	$W/m^2/K$	-	< 0,20	< 0,12
Min. Required heat transfer factor - through windows	$W/m^2/K$	-	< 1,0	< 0,85

*/ average family house of 140 m^2 of utilized area

**/ internal gains in EPD houses cover up to 35% of total heating heat consumption; solar gains up to 30 %, with remaining consumption approx. 35 %

***/ central Europe climate prefers internal gains to solar gains, with window area not exceeding 20 - 25 % of facade area

HYGIENIC MICROCLIMATE REQUIREMENTS

RECOMMENDED MICROCLIMATE VALUES FOR RESIDENCES

parameter	symbols & units	heating season		summer	
		optimum	acceptable	optimum	acceptable
Indoor temperature	ti [°C]	20,8+/-0,8	18 - 24	24+/-0,5	22,0 - 28,0
Relative humidity	rh _i [%]	30 - 55	20 - 70	-	-
Air movement	m/s	max. 0,15	max. 0,20	max. 0,15	up to 1,0

REQUIREMENTS FOR ROOM VENTILATION

regulation	air change rate	ventilation air volume
DIN 4701	0,5 h ⁻¹	
VDI 2088	0,4 - 0,8 h ⁻¹	
NKB Publication	≥ 0,5 h ⁻¹	30 m ³ h ⁻¹
BSF 1998:38	0,4 h ⁻¹	1,26 m ³ h ⁻¹ m ²
ASHRAE USA	-	27 m ³ h ⁻¹ person ⁻¹
STN 060210	≥ 0,3 h ⁻¹	
Czech Republic regulations		
ČSN 73 0540	0,1 - 0,5 h ⁻¹	
ČSN EN 15 251	0,07 - 0,7 h ⁻¹	15, 25, 36 m ³ h ⁻¹ person ⁻¹ / 2,16 - 5 m ³ h ⁻¹ m ²

REQUIREMENTS FOR KITCHEN AND BATHROOM VENTILATION

regulation	kitchen (m ³ h ⁻¹)	bathroom (m ³ h ⁻¹)	separate WC (m ³ h ⁻¹)
DIN 18017/3	40 - 60		20 - 30
DIN 1946/6 (Recommendation of ATREA s.r.o.)	40 - 60	40 - 60	20 - 30
ECE Compendium	36 - 180	36 - 180	
BSF 1998:38	36 - 54	36 - 108	36
ČSN EN 15251 (based on category)	50 - 72	36 - 54	25 - 36

WATER VAPOUR PRODUCTION VALUES

Water vapour sources	vapour production (g/h)	Water vapour sources	vapour production (g/h)
bathtub	700	houseplants	5 - 20
shower	2 600	Gas stove operation - gas combustion	1 500 g per 1 m ³ of gas
cooking - hot meals	600 - 1 500	Floor wiping, wet cleaning	1 000
cooking - daily average	100	Resting person	30
Laundry drying - spinned	50 - 200	Light work	40 - 200
Washing machine	300	medium difficult work	120 - 200
ironing	200	Hard work	200 - 300

COMPARING PARAMETERS OF RESIDENTIAL HEATING AND VENTILATING SYSTEMS

ensuring of required parameters	Standard hot-water heating				warm-air circulation heating	
	with window infiltration	weatherstriped windows (occasional ventilation)	with bathroom exhaust	with controlled ventilation & heat recovery	with controlled ventilation & heat recovery	with controlled ventilation & ground heat exchanger
Thermal comfort		-	○			
Room ventilation		○	○			
Occasional ventilation („party“ mode)	-	-	-			
Bathroom exhaust	-	-	○			
Air change efficiency	○	-	-	○		
Heat recovery	-	-	-			
Internal & external gain usage	-	-	-	○		
Supply air filtration	-	-	-			
Night precooling	-	-	-	○		
DX cooling	-	-	-	-	○	○ / ●

● accomplishes completely

○ accomplishes partially

- does not accomplish

PROBLEMS CAUSED BY POOR VENTILATION OF RESIDENTIAL ROOMS



Building damage by moisture



Mites



Fungi Allergies

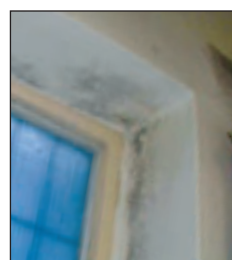

Molds Allergies

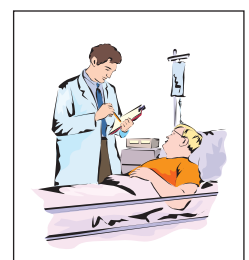

Resident sickness

ATREA SYSTEM

ATREA AIR-HANDLING SYSTEM FOR LOW-ENERGY AND PASIVE BUILDINGS

Comfort system of warm-air heating and ventilation with heat recovery

The principle of a modern and economical system consist of dual-zone circuit arrangement of forced air distribution in a family house:

- primary circuit provides circulation warm-air heating together with controlled fresh air ratio and heat recovery with air supply to every room via floor grilles
- secondary circuit provides separate air exhaust of bathrooms, kitchens, possibly closets with heat recovery
- during ventilation fresh air from heat recovery is mixed with recirculated air. This ensures supply of ventilation air to occupied rooms.

Both ductwork circuits are connected to a common DUPLEX RA3, RB3 or RK3 unit ventilator, designed and patented by ATREA s.r.o.

The DUPLEX units serve the year-round requirements of the house environment according to a selected operating mode on a CP controller:

- equal-pressure ventilation with heat recovery
- warm-air circulation heating and equal-pressure ventilation with heat recovery
- warm-air circulation heating (with occasional ventilation)
- positive-pressure summer ventilation (mainly night precooling), possibly cooling with air supply through a ground heat exchanger
- circulation cooling using a ground heat exchanger or mechanical cooling

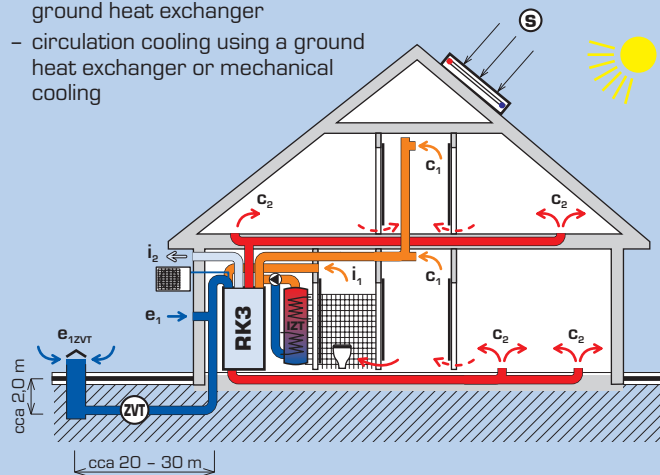

- Legenda:**
- C_2 circulating and fresh air to rooms
 - E_{1ZVT} outside air supplied through a ground exchanger
 - I_1 exhaust air from bathroom and kitchen
 - C_1 circulating air from rooms to AHU
 - I_2 outlet of recovered exhaust air

- RK3** DUPLEX RK3 heating unit ventilator
- IZT** integrated IZT heat storage tank (optional)
- ZVT** ground heat exchanger (optional)
- S** water solar collectors (optional)
- Outdoor condensing unit (mechanical cooling, optionally heating - heat pump)

Technical solutions and functions of the air system

- circulation and fresh air distribution to rooms is standardly distributed via individual flat (200 x 50 mm) ducts made of galvanized sheets laid in thermally insulated floor layer. It is recommended that supply air outlets with control be located under windows to avoid cold draft, as well as covering by furniture. This system also avoids acoustical interferences between different rooms.
- circulation air returns from individual rooms via slots under doors into a corridor where it leaves the space via a wall grille under ceiling into vertical ducts and goes back to the unit.
- the circulation and fresh air is then filtered in the unit by a G4 class filter with efficiency up to 94%, heated in a hot-water heating coil, and then is forced by a centrifugal low-speed fan through sound attenuators back to rooms.

- prefiltered and preheated (in a heat recovery core with efficiency up to 90%) fresh air from a facade or a ground heat exchanger is mixed with return air in the unit in a set ratio.
- stale air from bathrooms and water vapor from kitchens are constantly (possibly occasionally) exhausted via controlled valves and round duct with diameter of 100 to 160 mm and forced into the unit. The ductwork is installed in false ceiling. The exhaust air gives its heat to the fresh air in a heat recovery core. Cooled exhaust air is forced by a smaller exhaust fan through facade louvers out of the building.
- exhaust hoods above stoves are designed for circulation air with odour-absorbing carbon filters. They have adjustable volume flow of 150 to 450 m³/h.
- air distribution system controls the air volume flow and heating capacity to individual rooms
- hot-water or electric heating elements (ladders), possibly floor heating (heating panels) are used for temperature increase in bathrooms
- The compact DUPLEX RA3, RB3, or RK3 unit can be placed in a closet or small rooms, on a wall or under a ceiling (DUPLEX RB3 only).

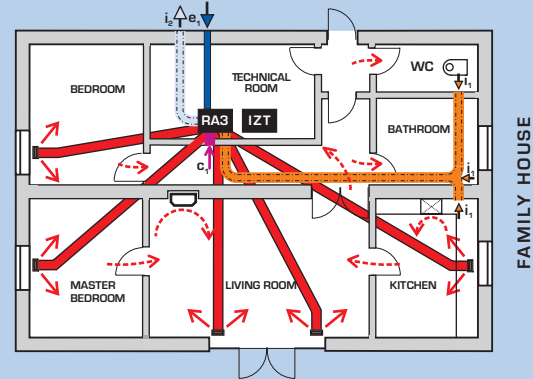

For low-energy and passive residential houses we recommend that $n = 0,15 - 0,2$ (h⁻¹) of daily average room ventilation rate be kept to ensure continuous indoor air quality in the whole building. That corresponds to approx. fresh air rate of 25 m³/h per person (Pettenkofer criterion).

The flat floor duct is designed for the max. air volume flow of 80 m³/h (at max. airflow of 2,0 m/s). Each duct then brings 600 W of heating capacity to rooms at the max. temperature drop 45/20 °C of the circulated air.

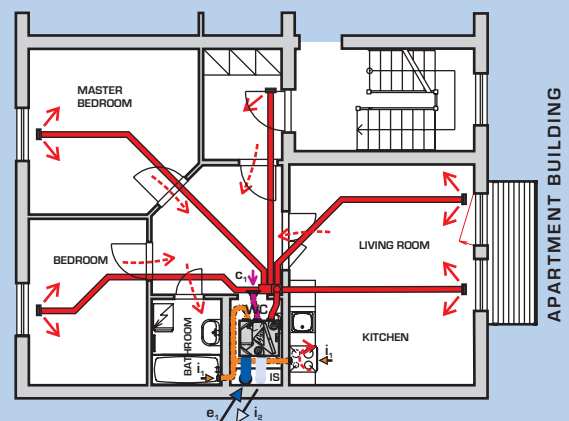

During duct and shaft design comply to ČSN 730872 -

- prevention against spread of fire in buildings via air system.

HEATING, VENTILATING AND COOLING OPERATING MODES

APARTMENT BUILDING

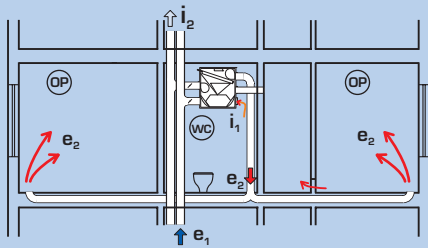

DUPLEX RB3 (also for RA3, Rk3)

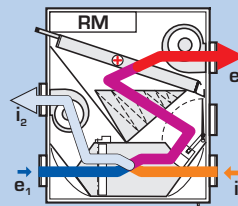

FAMILY HOUSE

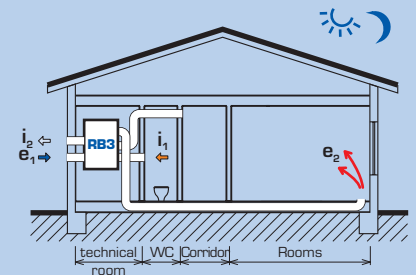

1 Equal-pressure ventilation

$$n_v = 0,3 - 0,5 \text{ (h}^{-1}\text{); } n_c = 0$$

Year-round - equal-pressure ventilation with adjustable air volume flow (80 to 150 m³/h), with heat recovery or using a by-pass.

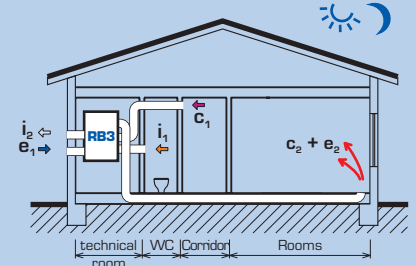
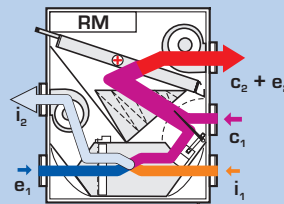
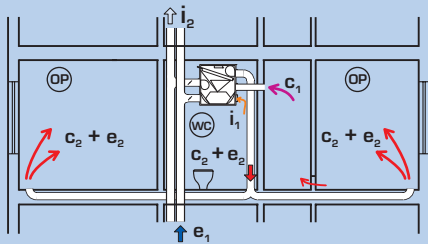

2 Circulation and ventilation

$$n_v = 0,3 - 0,5 \text{ (h}^{-1}\text{); } n_c = 0,5 - 1,5 \text{ (h}^{-1}\text{)}$$

Heating season - warm-air circulating heating and equal-pressure ventilation with heat recovery.

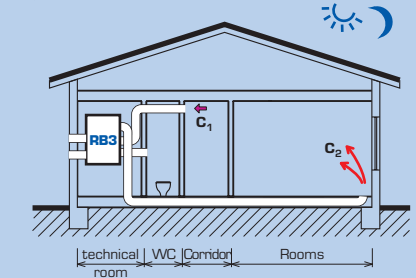
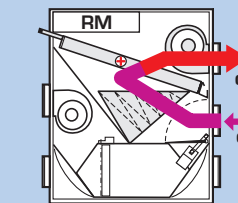
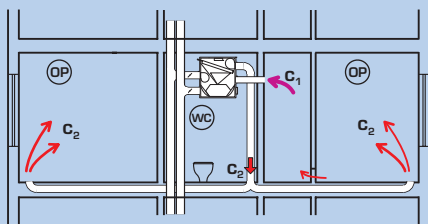

3 Circulation heating with occasional ventilation

$$n_v = 0; n_c = 0,5 - 1,5 \text{ (h}^{-1}\text{)}$$

Heating season - basic circulating heating mode. Ventilating mode „2” is switched on via an impuls from a bathroom or in periods using a timer, mode „1” is switched on from a kitchen.

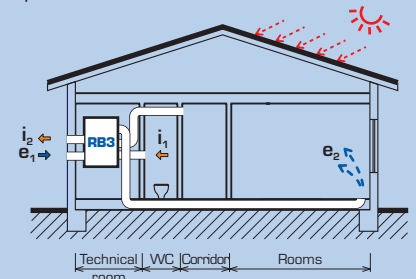
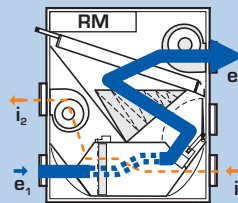
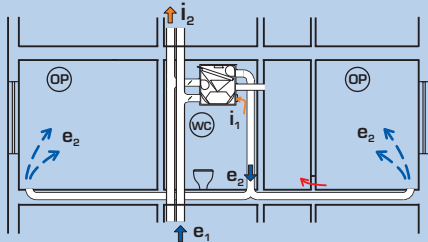

5 Positive-pressure ventilation - cooling

$$n_v = 0,5 - 2,0 \text{ (h}^{-1}\text{); } n_c = 0$$

Summer - positive-pressure room ventilation using outside air supply (optionally via a ground heat exchanger with cooling). Air exhaust via open windows.

Evaporators for cooling can be built in the DUPLEX RA3 and RK3 – ver. CHF, CHW
[without unit size change].
DUPLEX RB3 – CHF, CHW – ceiling-suspended version only (extended basic DUPLEX RB3 unit).

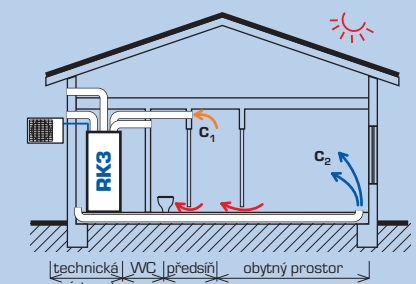
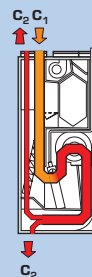

6a Circulation mode with mechanical cooling

$$n_v = 0,5 - 1,5 \text{ (h}^{-1}\text{)}$$

Summer - Intensive room circulation cooling using outdoor condensing unit („mechanical cooling“). When occupied, bathroom switch starts ventilation fan with adjustable stop delay. Kitchen switch starts mode 1 without stop delay. Cooling is not allowed in this case. Ventilation can also be switched on in set period.

c₁ ___ Inlet of circulating air from rooms into the unit
c₂ ___ Outlet of circulating air from the unit into rooms
e₁ ___ Inlet of fresh outside air

e₂ ___ Outlet of fresh air from the unit into rooms
i₁ ___ Inlet of exhaust (stale) air from bathroom into the unit
i₂ ___ Outlet of exhaust air from the unit

VENTILATION AND HEATING OF RESIDENTIAL POOLS

RESIDENTIAL POOLS

PRESENT-DAY PROBLEMS

- with insufficient evaporated moisture removal from water surface the RH value increases to a point, where a surface condensation of water vapor on building structure (thermal bridges) and whole surface of glazing takes place
- the condensate seriously damages building structure, runs down the glazing and is unacceptable for a user
- this is accompanied by occurrence of fungi (e.g. Cladosporium, Penicillium, Aspergillus versicolor)
- in many cases there are no vapour barriers in walls, moisture enters the exterior walls, condenses and dramatically reduces their thermal insulating characteristic
- in many cases there only are condensing dehumidifiers with insufficient airflow reach installed, does not cover the whole pool space, which results in heavy condensation and fungi occurrence in poorly ventilated space. At the same time, serious problems arise from evaporated chemical disinfection (chlorine, ozone, and halogens - bromine, iodine, chloroform) from the water

INDOOR AIR PARAMETERS OF POOLS

$t_a = 30\text{ }^\circ\text{C}$	air temperature
$t_w = 28\text{ }^\circ\text{C}$	water temperature
$rh_1 = 60\text{ až }65\text{ }^\circ\text{C}$	air relative humidity
$x_1 = 17,0\text{ g/kg}$	air specific humidity

The following values are used for calculation and design of air-handling systems:

- $\varnothing \Delta x_e = 14\text{ g/kg}$ calculated difference of specific humidities of indoor and outdoor air – for winter
- $\varnothing \Delta x_e = 10\text{ g/kg}$ calculated difference of specific humidities – for off season
- $\varnothing \Delta x_e = 5\text{ g/kg}$ calculated difference of specific humidities – for summer

The following empiric values are used for determining the amount of evaporated water from the pool surface (for common temperatures $t_a / t_w = 30/28\text{ }^\circ\text{C}$):

$\Sigma X = 180\text{ g/m}^2/\text{h}$	Residential pools in operation
$\Sigma X = 55\text{ g/m}^2/\text{h}$	Still water surface
$\Sigma X = 8\text{ g/m}^2/\text{h}$	Covered water surface

These values are put in the following equation to calculate required ventilation rate:

$$V_{\min} = \frac{F_B \times \Sigma X}{(X_1 - X_a) \cdot \rho} \quad (\text{m}^3/\text{h})$$

where: F_B ... Water surface area [m^2]
 ρ ... Supply air density [kg/m^3]

For common cases approximate specific ventilation requirements can be determined (i.e. Fresh air intake and stale air exhaust) based on season:

Residential pools:

- $V_1 = 11\text{ m}^3/\text{h}/\text{m}^2$ – winter season
- $V_1 = 16\text{ m}^3/\text{h}/\text{m}^2$ – off season
- $V_1 = 32\text{ m}^3/\text{h}/\text{m}^2$ – summer season

RULES FOR ECONOMICAL SOLUTION OF RESIDENTIAL POOL DESIGN

- choose a building envelope with the best thermal insulation and technical parameters
- avoid unnecessary large glazing (mainly in pool roofs)
- totally eliminate thermal bridges
- design perfect vapor barriers for walls and roofs
- design rectangular pool shapes to easily install rolling foil covers, possibly insulating cassettes made of polyurethane
- design connections to house only through a tight door, preferably through separately ventilated corridor
- in respect to possible losses and condensation in ducts locate the ventilating unit as close as possible to pool

RULES FOR VENTILATION AND HEATING OF RESIDENTIAL POOLS

The rules come from experience with many newly built or retrofitted pools in Czech Republic in recent years:

- ensure thorough ventilation of the whole space; avoid poorly ventilated corners with possible condensation
- always ensure supply of dry warm air with low RH value on glazing with sufficient speed and reach
- keep the whole space in negative pressure (min. 95 %) to avoid risk of water vapor escaping into adjacent spaces or into a structure through an incorrectly made vapor barrier
- always design the ceiling distribution ductwork in the pool made of stainless material with slot or nozzle outlets; possibly of aluminum finished polyurethane, with slot outlets without control (due to complicated access)
- ensure perfect tightness of stainless floor ductwork, sloping towards a condensate drain, access for cleaning and excellent thermal insulation
- design air distribution ductwork outside the pool of tight duct (e.g. Polyurethan), sloping towards a condensate drain, and thermally insulated. Never install exhaust grilles in false ceiling through a cut vapor barrier!
- design suction grille centrally opposite the glazing, under the space ceiling
- design the air distribution for very small spaces (e.g. with only one window or in a basement) only by a central jet air outlet (adjustable)
- always isolate the pool air-handling system from the one serving the house, including supply and exhaust ducts, to avoid drafts (backdraft dampers do not guarantee continuous and trouble-free operation)
- due to unsteady residential pool operation (e.g. 1 – 2 hours a day) it is ideal to install the air system with warm-air heating to achieve required air temperature quickly, in just several dozens of minutes. It is recommended that thermal insulation and vapor barrier be installed on the inside wall).
- air-handling units for pools must be suitable for aggressive environment (chlorine), i.e. with heat recovery core made of plastic material, condensate drain pan of stainless steel or with a special finish. Caution during installation of pools with sea water. Special material must be used in AHU units.
- it is recommended that as a basic heating system a floor distribution system be installed with connection to a low-temperature heat source (HP, solar energy), possibly a system of floor-standing convectors below windows, with anticorrosive finish with a special design to avoid human injury

VENTILATION AND HEATING OF RESIDENTIAL POOLS

VENTILATING AND HEATING MODES OF A DUPLEX RDH POOL UNIT

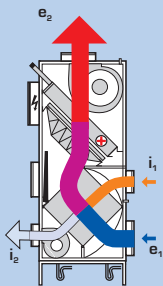

1

Equal-pressure ventilating mode

Equal-pressure ventilation with heat recovery in automatic mode, controlled by a humidistat when unit air volume is set at „0“ (OFF on the controller).

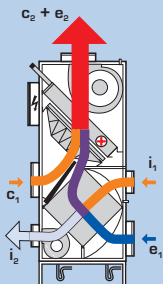

2

Circulation heating and ventilating mode

Warm-air circulation heating and equal-pressure ventilation with heat recovery controlled automatically by a humidistat and a thermostat; with circulating and ventilation air volume up to 1 800 m³/h and 500 m³/h respectively.

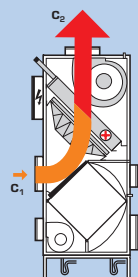

3

Circulation heating mode

It is used for heating and tempering of pools out of operation or for temperature increase. During RH increase, changes automatically to mode 2 - ventilation. Room thermostat controls the temperature.

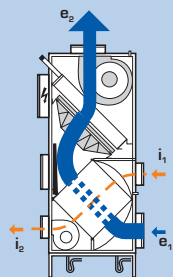

5

Positive-pressure ventilating mode

Intensive summer positive-pressure ventilation at full outdoor air intake (possibly via a ground exchanger). Air exhaust through open windows.

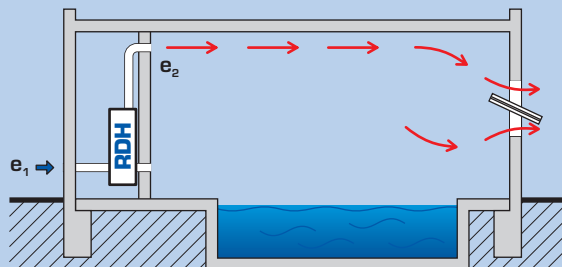
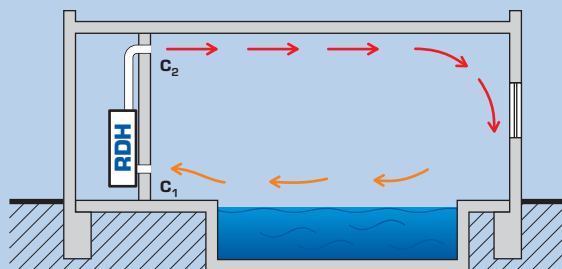
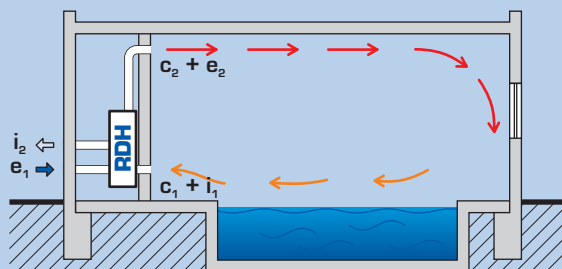
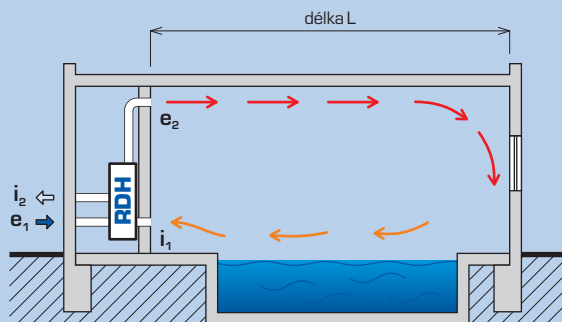

c_1 Inlet of circulating air into the unit
 c_2 Outlet of circulating air from the unit
 e_1 Inlet of fresh outdoor air into the unit

e_2 Outlet of fresh air from the unit
 i_1 Inlet of exhaust (stale) air into the unit
 i_2 Outlet of exhaust air from the unit

Note: Ductless distribution with nozzle air outlets can only be used for the smallest pools without glazing (L max = 5 m)

CROSS SECTION OF POOL VENTILATION

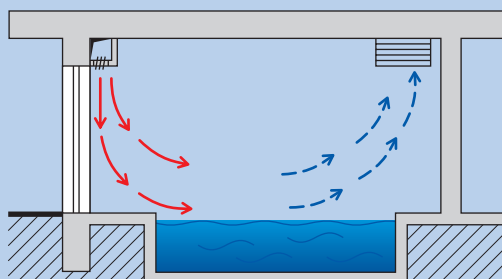

Longitudinal ventilation air supply above windows or glazing; distribution ductwork of polyurethan with aluminum finish. Air distribution through nozzles above glazing, centralized air exhaust through a stainless grille.

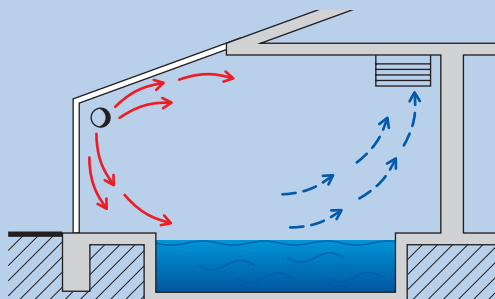

Longitudinal ventilation air supply in glazing; distribution round ductwork of AISI 304 stainless sheets. Air distribution through perforation or nozzles vertically or under an angle on glazing.

ENERGY SYSTEMS FOR HEATING, VENTILATION AND SERVICE WATER HEATING IN FAMILY HOUSES

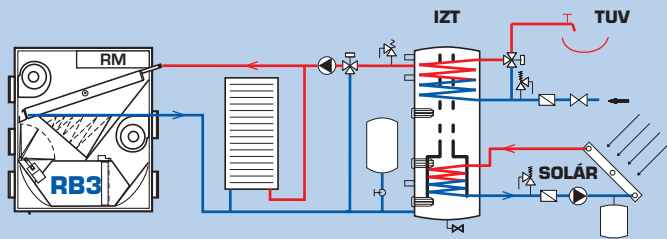

Integrated heat storage tank of the IZT line for solar heating of hot service water (HSW) and space heating (SH) supplement with built-in upper element for flow heating of HSW, lower element of a solar exchanger for connection of solar collectors, and electric elements for heating season and summer. The heat storage tank of the IZT line can be hooked up to a biomass-burning boiler or a heat pump.

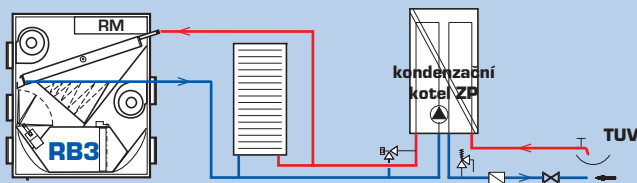

Condensing natural gas boiler, possibly an electric boiler or a heat pump with a built-in or separate HSW heater. Standard gas-burning boilers already have a built-in capacity controller based on water temperature ensuring modulating capacity control.

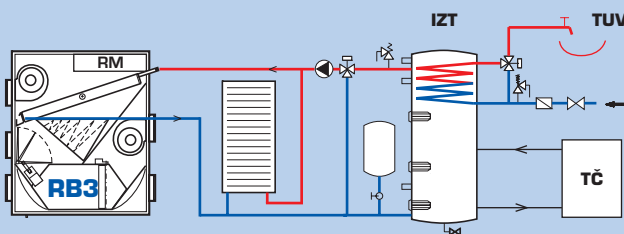

"Air-to-water" heat pump with bivalent electric supply, integrated heat storage tank of the IZT line for space and HSW heating.

ENERGY SYSTEMS FOR HEATING, VENTILATION AND SERVICE WATER HEATING IN RESIDENTIAL POOLS

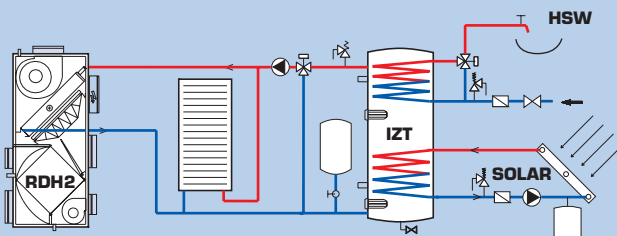

Integrated heat storage tank of the IZT line for solar heating of hot service water (HSW) and space heating (SH) supplement with built-in upper element for flow heating of HSW, lower element of a solar exchanger for connection of solar collectors, and electric elements for heating season and summer. The heat storage tank of the IZT line can be hooked up to a biomass-burning boiler or a heat pump.

SOURCES AND APPLIANCES

Possible sources → Integrated heat storage tank → Appliances

Solid-fuel-burning boiler
- wood, pelets, chips
fytomasss

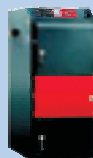

Heat pump
(air-to-water,
ground-to-water)



Solar collectors



Electricity
(electric elements in IZT)



IZT



IZT 615
IZT 925

Appliances



Warm-air heating
(heating coil built-in
the DUPLEX)

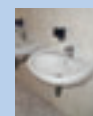

Hot service water heater
(flow type)

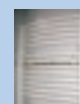

Heating elements
(mainly in bathrooms)



Floor heating
(e.g. Bathrooms)

FUNCTIONS OF CP 05 RD CONTROLLER

Built-in digital control

DUPLEX R_3 units are standardly equipped with a digital module placed in a built-in control box. It enables heat supply control using a switch or voltage, 0-10V heat capacity control, control of two heating shutoff valves. It also enables to control heating water to keep constant supply air temperature. Optionally can be equipped with mechanical cooling control.

A system can be controlled by:

- a CP 08 RD series controller (programmable digital controller)
- a building management system via a communication gateway (on request)

The CP 08RD controller enables simple remote control of all unit operating modes and room temperature. Operation is based either on a program of manual setting. The system provides comfort automatic operation using a bathroom or a kitchen switch. Standard controls enables using also other automatic functions (e.g. periodic ventilation). With the EC fan technology optimal building heating capacity and ventilation rate can be achieved.

Functions

The RM digital control module together with the CP controller provides the following functions:

- selection of a basic unit operating mode:
 - 1) equal-pressure ventilation with heat recovery
 - 2) circulation heating and ventilation with heat recovery
 - 3) circulation heating (occasional ventilation using a bathroom or a kitchen switch or periodic ventilation using a timer setting)
 - 4) circulation heating based on room temperature
 - 5) positive-pressure ventilation – summer
 - 6) circulation cooling using a ground heat exchanger or mechanical cooling
- heating and ventilation mode setting

- manual or automatic (based on a heating season/nonheating season program) operating mode selection
- automatic room temperature control with weekly schedule for heating season/nonheating season (water temperature control by a hot water mixing valve or direct control)
- indikace provozních a poruchových stavů na displeji
- automatic by-pass and mixed-air damper control ensuring equal pressure during ventilation mode
- occasional ventilation using bathroom and kitchen switch with start/stop delay selection (possible usage of 24 V, e.g. pool humidistat)
- ventilation control via 0 – 10 V signal, e.g. CO₂ sensor
- STOP switch (e.g. to connect to a security system to prohibit ventilation etc.)
- possibility to connect a second thermostat (e.g. individual bathroom heating, etc.)
- boiler start command (voltage-free switch)
- heating circulation pump power supply max. 230 V / 0,5 A, two heating circuit control
- max. supply air temperature setting and limiting
- possible constant supply air temperature operation
- either gas-fired condensing boiler capacity control or mixing heating valve control, both using 0 – 10 V
- possibility to change programmed setting of EC fan performance
- heat recovery core condensate freeze-up protection
- hot-water heat exchanger freeze-up protection
- output for automatic ground heat exchanger damper control based on outdoor temperature or an output for fresh air shutoff damper
- an additional module can control selected types of outdoor condensing units with heating mode in off-season

SYSTEM WIRING DIAGRAM

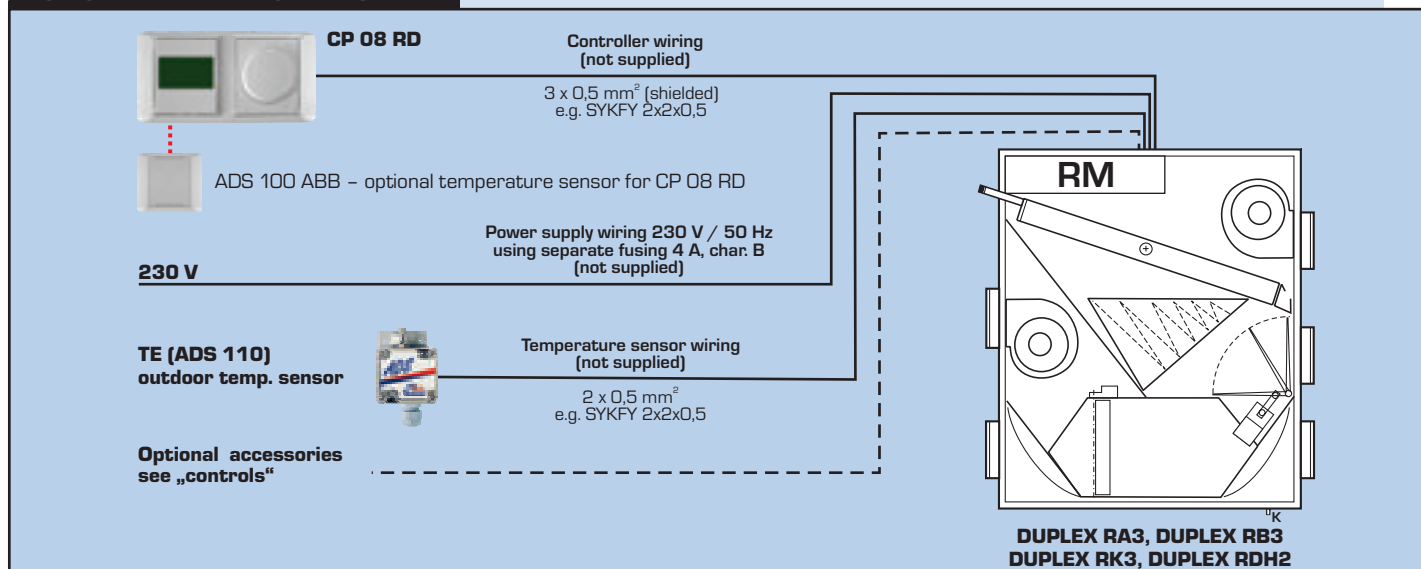

INPUTS AND OUTPUTS OF THE DIGITAL MODULE

input/output	recommended cable	functions and usage
D1, D2, D3	3x CYKY 20 x 1,5	input – occasional ventilation operation using a 230 V bathroom switch with fan stop/start delay setting
D4	3x CYKY 20 x 1,5	input – occasional ventilation operation using a 230 V kitchen switch (no stop delay, with so-called odor spread protection function); possibility to use ventilation damper control
IN1; IN 2	SYKFY 2 x 2 x 0.5	input – occasional ventilation operation using a switch (no stop delay) – e.g. pool humidistat or CO ₂ sensor 0-10 V input. Adjustable ventilation rate. May be used for prohibited ventilation.
STP	SYKFY 2 x 2 x 0.5	input – switch – switches off a unit
TR	SYKFY 2 x 2 x 0.5	input – optional second room thermostat for a space that may be heated by hot water (e.g. bathroom)
SV	CYKY 3D x 1,5	output – for a ground heat exchanger damper or an e, shutoff damper control
YV1, YV2	CYKY 3C x 1,5	output - 230 V / 0,5 A – opening valve servo at HW supply to R_3 – EC, YV2 to bathroom
KK	CYKY 2A x 1,5	output - boiler operation, optionally connecting with 230 V circulating heating pump for an IZT

Other inputs and wirings enabling control. 2x zone ventilation damper; air and brine circulation ground heat exchanger; connection to supervisory control systems – see detailed electric diagrams

ATREA SYSTEM PARAMETERS

ADVANTAGES OF WARM-AIR HEATING AND VENTILATION

- heating occupied rooms and ventilating the whole building
- ensuring continuous hygienic room airchanges with possible controlled occasional air volume increase - without opening windows
- saving up to 90 % of ventilation cost
- saving air system operation cost thanks to use of EC fans
- avoiding growth of molds
- perfect cleaning the indoor air by continuous air circulation through efficient filters
- effective summer night interior „precooling“
- avoiding all risks of hot-water heating
- conveying heat medium (circulating air) together with ventilation or cooling air via a common house ductwork
- utilizing all energy gains from a household operations to preheat ventilation air
- utilizing air volume of a whole house or an apartment by a total air circulation
- by installing the ground heat exchanger helping to preheat fresh air in winter (by up to 15 °C) and to cool the air in summer (by up to 12 °C) . This supplements 2 kW of mechanical cooling
- possible adding mechanical cooling/heat pump equipment
- enabling to utilize solar gains from windows or fireplaces and conveying them directly to all rooms
- enabling perfect use of solar energy for all rooms by quick response to external and internal heat gains
- avoiding noise transfer between rooms by using separate flat floor-installed ductwork
- enabling controlled individual air supply to each room by floor ductwork and air outlets

DAILY TREND OF CO₂ CONCENTRATION - INDICATION OF HUMAN ODOURS

CO₂ trend for family house with warm-air heating and ventilation

- at production of CO₂ 18 l h⁻¹ person (6:00 - 22:00) - family average
- at production of CO₂ 14 l h⁻¹ person (22:00 - 6:00) - family average

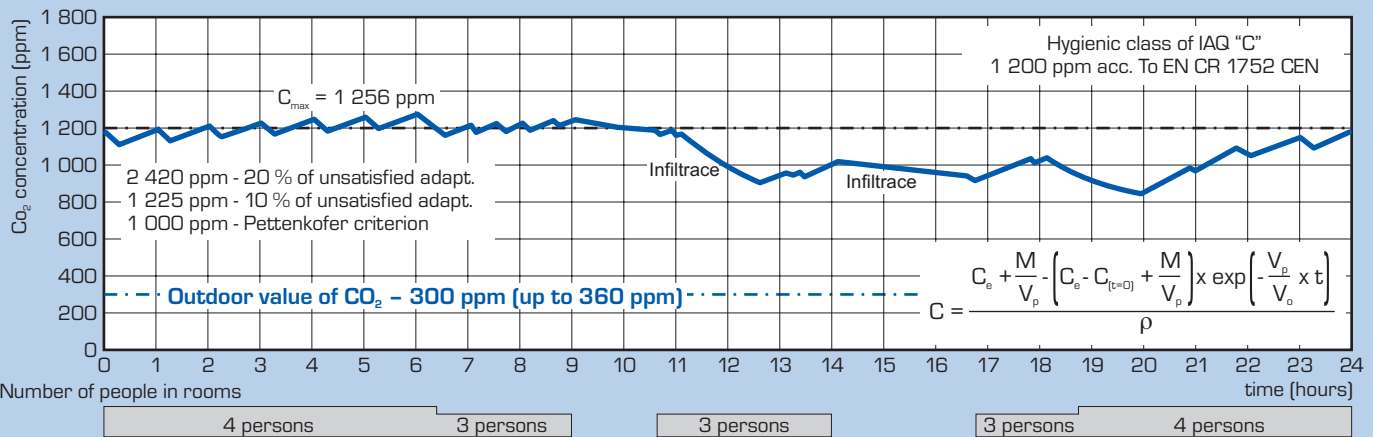

CO₂ trend for different rooms

- at production of CO₂ 18 l h⁻¹ person (6:00 - 22:00) - family average
- at production of CO₂ 14 l h⁻¹ person (22:00 - 6:00) - family average

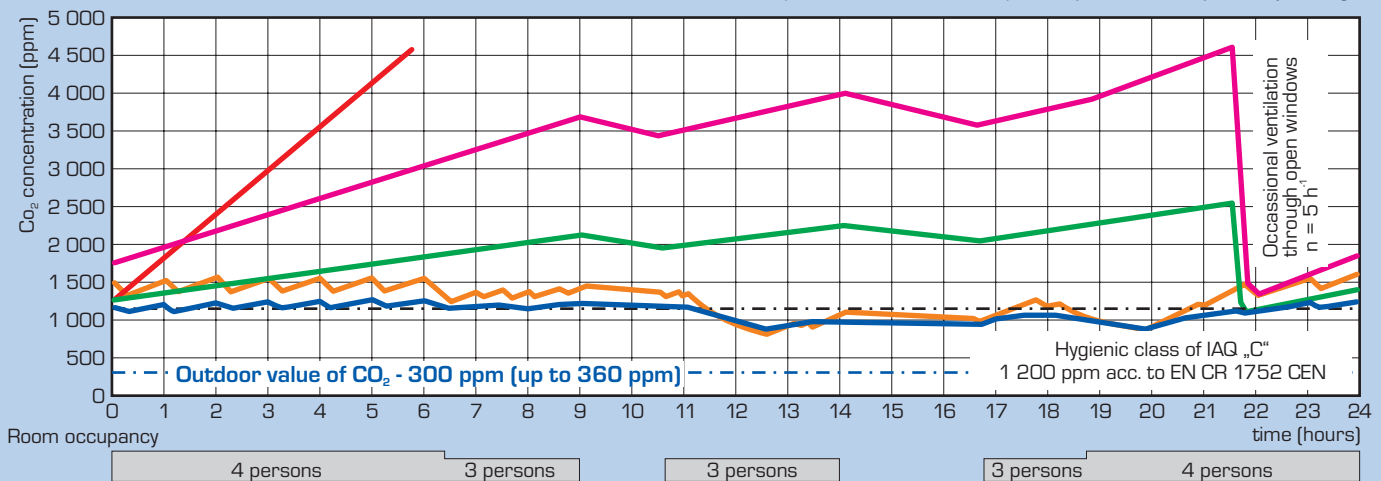

- Family house with warm-air circulation heating, infiltration + occasional ventilation ... $V_o = 406\ \text{m}^3$; $\varnothing n_{e24} = 0,15\ \text{h}^{-1}$, closed windows
- Family house with warm-air circulation heating, with infiltration only $V_o = 406\ \text{m}^3$; $\varnothing n_{e24} = 0,05\ \text{h}^{-1}$, occasional ventilation through windows
- Apartment with warm-air circulation heating, infiltration + occasional ventilation $V_o = 188\ \text{m}^3$; $\varnothing n_{e24} = 0,25\ \text{h}^{-1}$, closed windows
- Apartment with warm-air circulation heating, infiltration $V_o = 188\ \text{m}^3$; $\varnothing n_{e24} = 0,048\ \text{h}^{-1}$, occasional ventilation through windows
- Bedroom with hot-water heating, infiltration (occupied by 2 persons) $V_o = 35\ \text{m}^3$; $\varnothing n_{e24} = 0,05\ \text{h}^{-1}$; closed windows

GROUND HEAT EXCHANGER (GHE)

AIR INTAKE THROUGH LOUVERS IN A WALL
 - at outdoor temperature 0 - 25 °C
 (Off season - regeneration of earth around the ground exchanger)

AIR INTAKE THROUGH A GROUND HEAT EXCHANGER
 - at outdoor temperature > 25 °C
 (summer cooling)
 - at outdoor temperature < 0 °C
 (winter reheat)

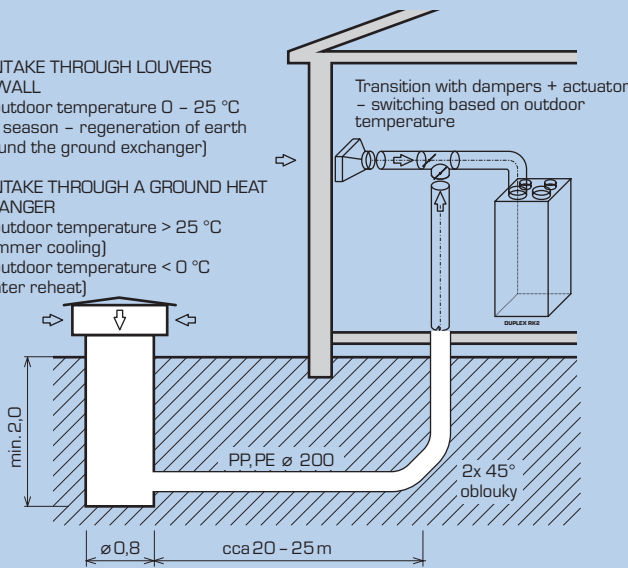

Technical description

The ground heat exchanger (GHE) is used for natural air conditioning (cooling) of buildings in summer and for ventilation air preheat in winter. It also protects the heat recovery core against freezing. The ground exchanger comprises of an underground duct of length of 20 to 25 m, an inlet well and a well cover with a filter above the ground. The supply air is heated in the ground exchanger during winter from -15 °C to +2 - +5 °C, and is cooled during summer from +32 °C to +19 - +22 °C. The ventilation air enters the DUPLEX unit during off season through outdoor louvers located on building facade. Switching between air intake from louvers or the ground exchanger is controlled automatically based on an outdoor temperature sensor. For other GHE options see respective documentation.

Principles of a ground heat exchanger installation:

- duct \varnothing 200 to 250 mm laid min. 1,8 m in ground with 1 - 2 % slope for good condensate drainage, covered with soil
- duct length 20 to 25 m, straight run without bends no greater than 30° with respect to cleaning
- material of drainage pipe (PP, PE) \varnothing 200 to 250 mm smooth, connected by rings
- recommended soil: moist clay, no sand or gravel etc.
- access well of the ground exchanger made of polypropylene of recommended \varnothing 800 mm

MECHANICAL COOLING

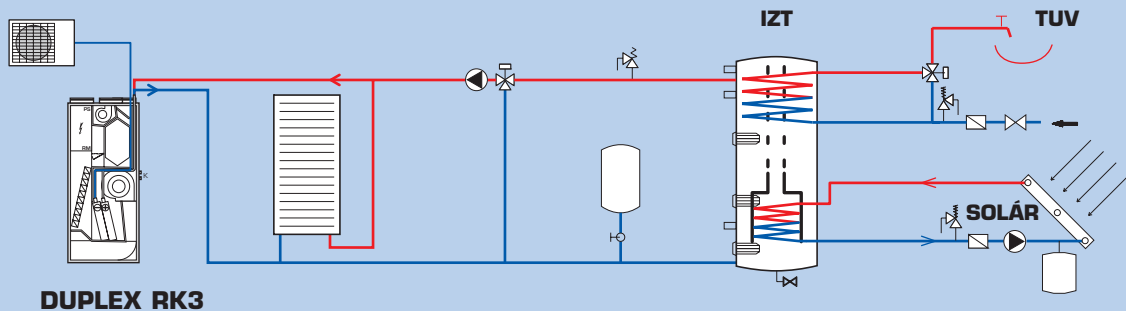

DUPLEX RK3

By using outdoor condensing unit the building can be cooled with capacity up to approx. 4 kW in summer and heated with approx. 3,5 kW in off season. The equipment is an air-to-air heat pump. Details in respective technical documentation.



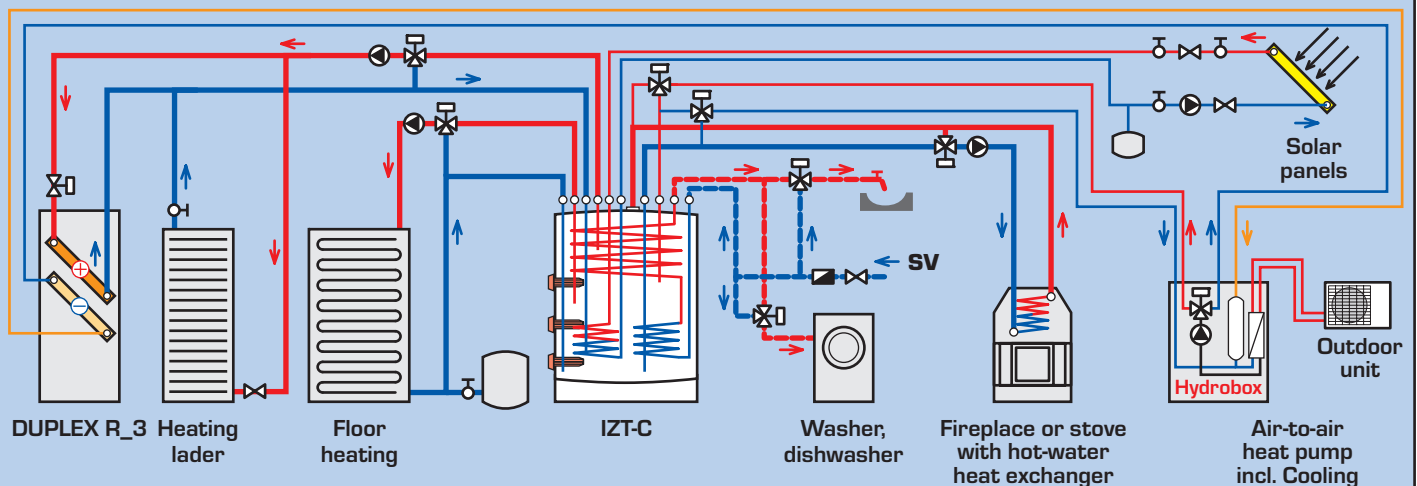





ENERGY SYSTEM IZT-C

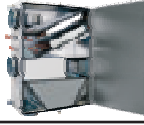

In case of hydrobox use, separating the heat pump refrigerant - water circuits, the outdoor unit can be used for HW and HSW heating. Cooling then is provided by chilled water. Heat pump air-to-water system connection. Detailed information in respective documentation.

ATREA MODULAR AIR HANDLING SYSTEM





DUPLEX RB, RC, RK, RDH UNITS, CONTROLS AND ACCESSORIES

	DUPLEX RA3 - EC	The unit in basic configuration includes circulating supply and exhaust CE centrifugal fans, counterflow heat recovery core, mixing and by-pass dampers with actuators, hot-water heating coil, G4 class circulated air filter; expanded-metal prefilters, attenuating chamber of supply air; operation & maintenance manual. Extended version CHF, CHW may be equipped with mechanical cooling - DX or chilled-water coil.
	DUPLEX RA3 - EC, CHF (CHW)	
	DUPLEX RB3 - EC	The unit in basic configuration includes circulating supply and exhaust CE centrifugal fans, counterflow heat recovery core, mixing and by-pass dampers with actuators, hot-water heating coil, G4 class circulated air filter; expanded-metal prefilters, attenuating chamber of supply air; operation & maintenance manual. Suitable for occupied spaces with heat loss up to 3,3 kW. Extended version CHF, CHW may be equipped with mechanical cooling - DX or chilled-water coil.
	DUPLEX RB3 - EC, CHF (CHW)	
	DUPLEX RK3 - EC	The unit in basic configuration includes circulating supply and exhaust CE centrifugal fans, counterflow heat recovery core, mixing and by-pass dampers with actuators, hot-water heating coil, G4 class circulated air filter; expanded-metal prefilters, attenuating chamber of supply air; operation & maintenance manual. Suitable for occupied spaces with heat loss up to 7 kW. Extended version CHF, CHW may be equipped with mechanical cooling - DX or chilled-water coil.
	DUPLEX RK3 - EC, CHF (CHW)	
	DUPLEX RDH2 1500 / 500	A unit for pools made of stainless steel. The unit in basic configuration includes circulating supply and exhaust AC centrifugal fans, counterflow heat recovery core, mixing and by-pass dampers with actuators, three-row hot-water heating coil, G4 class circulated air filter; expanded-metal prefilters, operation & maintenance manual.
	DUPLEX RDH2 1500 / 700	
	DUPLEX RDH2 2200 / 500	
	DUPLEX RDH2 2200 / 700	
	Digital control module	Built-in digital control module with installed temperature sensors enabling wide selection of controls, e.g. based on supply air temperature etc., cooling control, other input_output connection.
	ADS 110	Digital TE sensor (outdoor temperature), required for units with built-in digital control module. To be installed on building's outside wall.
	CP 08 RD controller White Ivory white	Controller for units with built-in controls - digital version with a display, integrated temperature control and built-in room temperature sensor. Enables comfort control of the whole system in automatic or manual mode. Wide range of parameter setting, including zoning.
	CM 907	Weekly programmable room thermostat (Honeywell).
	Sensors	Wide range of humidistats, IAQ sensors, thermostats, etc.
	Filtr textiles, cartridges	
	FT G4 / FT F7	Replacement filter textiles of basic G4 filtration class (pack of 5 pieces - 5 replacements)
	FK G4 / FK F7	Replacement filter cartridge of G4/G7 filtration class
	AOYR14LCC (FUJITSU) AOYR18LCC (FUJITSU)	FUJITSU outdoor heat pump condensing unit with inverter for mechanical cooling or heating (off season).



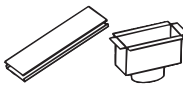



For detailed description, ordering codes and possible combinations see respective unit catalog sheets or price list.

HEAT SOURCES, DUCTWORK, EQUIPMENT

ATREA s.r.o. offers a complete air distribution system and energy supply for DUPLEX RA3, RB3, RDH2 and RK3 units. For detailed specifications see „System of warm-air heating and ventilation with heat recovery for family houses - Design data, product catalog“

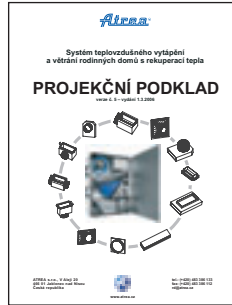
	IZT-A; -B, -C, -D, -I - integrated heat storage tanks of the IZT line Steel zero-pressure vessels with built-in spiral elements for flow heating of service water. Additional spiral element for heating by solar collectors. Fitted with electric elements in lower and middle part.		Ductwork Special flat ducts for floor air distribution including fittings, transitions, plenums, round ducts, attenuators, outlets, rain louvers (see product catalog).
	RG20-IZT; RG30-IZT - control panels for IZT storage tanks Range of panels for IZT includes fusing and control devices, thermostats and temperature sensors.		Round duct Complete product range of round ducts including special attenuating types (see product catalog).
	Adjustable floor and wall grilles Wide range of different floor and wall air outlet grilles.		Hot-water circuit equipment Complete range of safety and control devices for connection of heat energy sources and equipment.

TECHNICAL AND DESIGN DATA OF ATREA SYSTEM

					
Electrical installation	Product catalog	Detailed design data	Ground heat exchanger data	CD	Selection program

www.atrea.cz